

Panasonic

Cordless Phone

Model No. **KX-TC1220ALW**
KX-TC1220NZW

Operating Instructions



Preparation

Basic Operation

Advanced Operation

Useful Information

Caller ID Compatible

PLEASE READ BEFORE USE AND SAVE.

Charge the battery for about 10 hours before initial use.

Before Initial Use

Thank you for purchasing your new Panasonic cordless telephone.

For Australia

When you subscribe to Caller ID services from your telephone operator, this telephone will display the caller's phone number. When available from your telephone operator, this telephone will also display the number of the second call or call waiting.

For New Zealand

Caller ID, where available, is a service provided by the telephone company. After subscribing to Caller ID, this phone will display a caller's phone number.

For your future reference

Serial No. _____
(found on the bottom of the unit)

Date of purchase _____

Name and address of dealer _____

Attach or keep original receipt to assist with any repair under warranty.

Accessories (included)

AC Adaptor (p. 11)

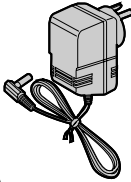

one

Telephone Line Cord (p. 11)

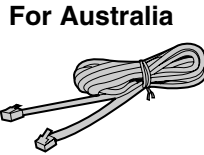

one

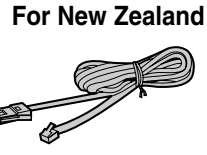

one

Battery (p. 12)

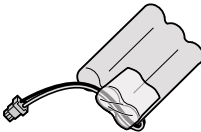

one

Handset Cover (p. 12)

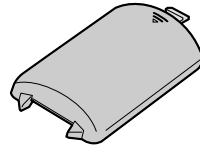

one

For Australia only

Telephone Plug (p. 11)

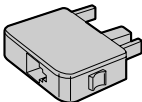

one

Wall Mounting Adaptor (p. 50)

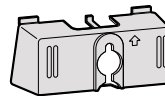

one

For Best Performance

Battery Charge

A rechargeable Nickel Cadmium (Ni-Cd) battery powers the handset. Charge the battery for about **10 hours** before initial use (p. 12).

- **Clean the handset and the base unit charge contacts with a soft, dry cloth once a month. Clean more often if the unit is subject to grease, dust or high humidity.** Otherwise the battery may not charge properly.



Base Unit Location

Calls are transmitted between the base unit and the handset using wireless radio waves. **For maximum distance and noise-free operation**, the recommended base unit location is:

Away from electrical appliances such as a TV, personal computer, cellular phone, charging units or another cordless phone.

In a high and central location, preferably where there are no obstructions.

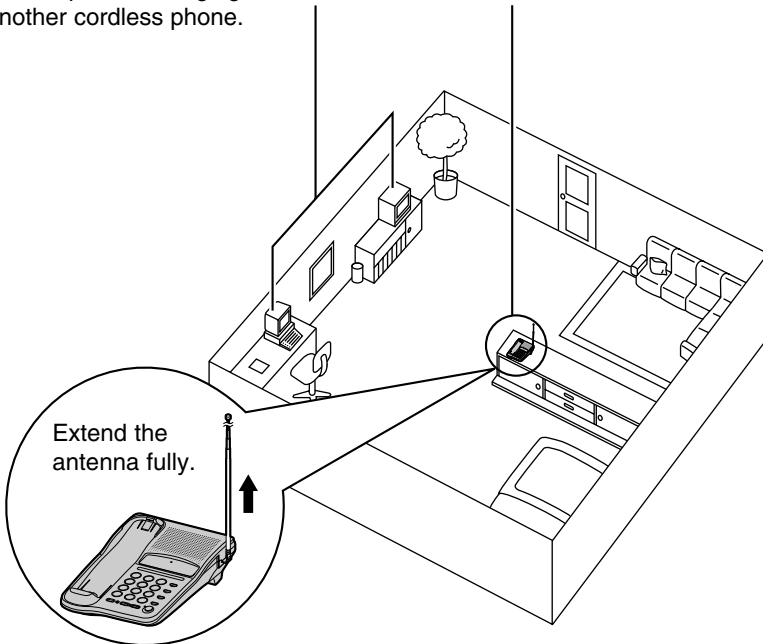

Contents

Preparation

Location of Controls	6
Display	8
Settings	11
Connections	11
Installing the Battery in the Handset	12
Battery Charge	12
Time and Date Adjustment	14
Programmable Functions	16
Setting the Auto Talk Feature	17
Selecting the Ringer Volume	18
Setting the LCD Contrast	19
Storing Your Area Code	20

Basic Operation

Making Calls	21
With the Handset	21
With the Base Unit (Digital Duplex Speakerphone)	23
Simultaneous Keypad Dialling	25
Answering Calls	26
With the Handset	26
With the Base Unit (Digital Duplex Speakerphone)	26
Caller ID Service	27
Using the Caller List	29
Viewing the Caller List	29
Calling Back from the Caller List	31
Editing the Caller's Phone Number	32
Storing Caller List Information in the Directory	33
Erasing Caller List Information	34

Advanced Operation

Speed Dialler	36
Storing Phone Numbers in Memory	36
Dialling a Stored Number	36
Using the Directory	37
Storing Names and Numbers in the Directory	37

Selecting Characters to Enter Names	39
Finding Items in the Directory	41
Dialling from the Directory	42
Editing an Item in the Directory	43
Erasing an Item from the Directory	44
Intercom	45
Transferring a Call Using the Intercom	46
Special Features	47
How to Use the PAUSE Button (For Analog PBX Line/Long Distance Service Users)	47
Automatic Security Code Setting	48
Call Waiting and Caller ID Compatible (For Australia only)	48
RECALL Button	48

Useful Information

Wall Mounting	50
Battery Replacement	52
Adding Another Phone	53
Before Requesting Help	54
Safety Instructions	57
Important Information (For Australia only)	59

Location of Controls

Handset

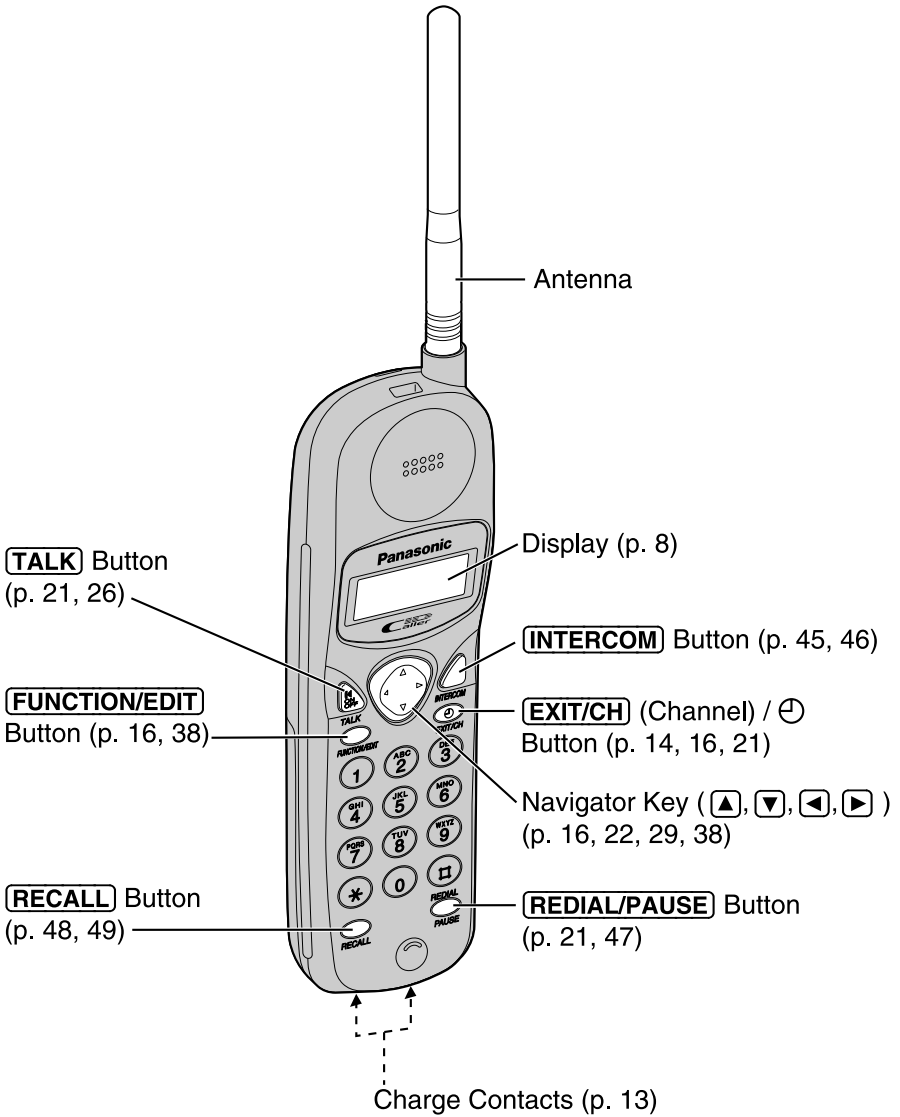

Base unit

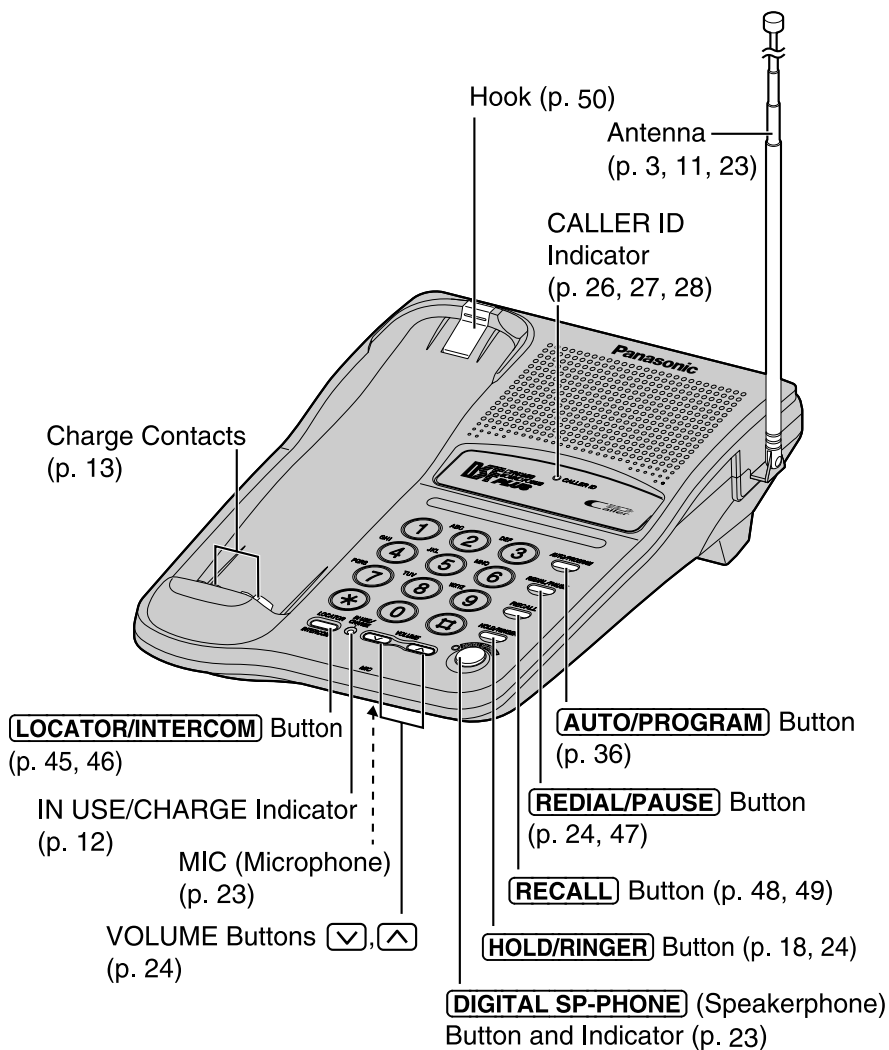

Display

The handset shows you information and instructions on the display. The display prompts are shown below.

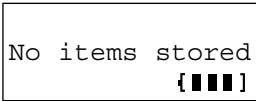

```
No items stored
{■■■■}
```

The Caller List is empty. This is displayed while the handset is on the base unit.

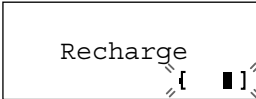

```
Recharge
{■}⌋
```

The battery needs to be charged. Place the handset on the base unit to charge the battery (p. 13).

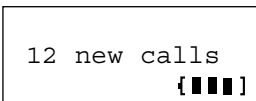



```
12 new calls
{■■■■}
```

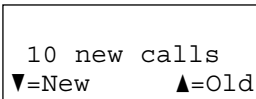

The display shows the number of new calls and the battery strength while the handset is on the base unit.



```
10 new calls
▼=New ▲=Old
```

This display will be shown when:

- you lift the handset off the base unit, or
-  or  is pressed when the handset is off the base unit.

To search from the most recent call, press . To search from the oldest call, press  (p. 29).

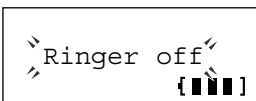

```
⌋Ringer off⌋
{■■■■}
```

When the handset ringer volume is set to OFF (p. 18), “Ringer off” will flash for about 45 seconds before the handset returns to the standby mode (p. 13).

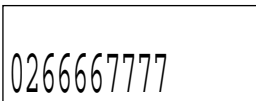

```
0266667777
```

When a call is received, the display shows the caller’s phone number after the first ring.

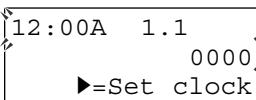

```
12:00A 1.1
0000
▶=Set clock
```

Clock has not been set. Please set time and date (p. 14).



Talk
01-06-35 [■■■■]

During a conversation, the display shows the length of the call (ex. 1 hour, 6 minutes and 35 seconds). The battery strength is also displayed (p. 12).

No link to base
Place on cradle
and try again.

The handset has lost communication with the base unit. Place the handset on the base unit and try again.

0355566677
11:20A 20.12 X3

This is information from the Caller List. The display shows:
— the caller's phone number,
— the time and date of the last call (ex. Dec. 20, 11:20 AM), and
— the number of times called (ex. 3 times).

Ann
0276543210

This is a name from the directory. The stored name and phone number are displayed.

Press INTERCOM

The base unit is paging the handset (p. 45).

Intercom
00-00-07 [■■■■]

The handset and the base unit are in the intercom mode (p. 45).

Intercom hold
00-01-12 [■■■■]

An outside call has been put on hold by the handset user in the intercom mode. To release the hold, press **TALK** or **DIGITAL SP-PHONE** (p. 46).

Hold
00-01-12 [■■■■]

An outside call using the handset has been put on hold by pressing **HOLD/RINGER**. To release the hold, press **TALK** or **DIGITAL SP-PHONE** (p. 24).

➔ Display

Not available

◀, ▶, or **INTERCOM** was pressed, while the base unit was in use.

Caller's list
No items stored

When trying to enter the Caller List while the handset is off the base unit, the Caller List is empty.

Directory list
No items stored

When trying to enter the directory list while the handset is off the base unit, the directory is empty.

Memory is full

When trying to store an item or Caller List information in the directory, the directory memory is full (p. 33, 38).

Save error

While programming items, the handset has lost communication with the base unit. Move closer to the base unit and try again.

Settings



Connections

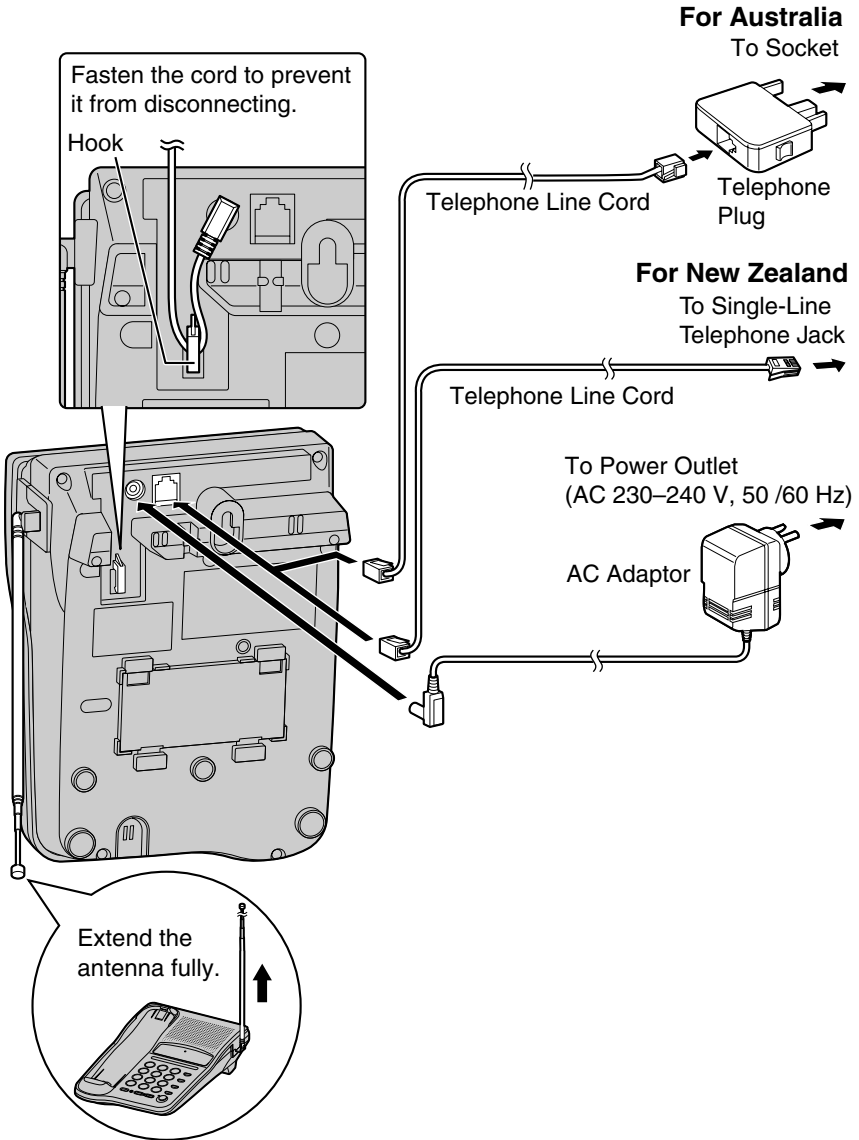

- USE ONLY WITH Panasonic AC ADAPTOR PQLV14AL.
- The AC adaptor must remain connected at all times. (It is normal for the adaptor to feel warm during use.)
- To connect a standard telephone on the same line, see page 53.
- If your unit is connected to a PBX which does not support Caller ID services, you cannot access those services.

Installing the Battery in the Handset

Install the battery in the handset and close the handset cover, locking it into place.

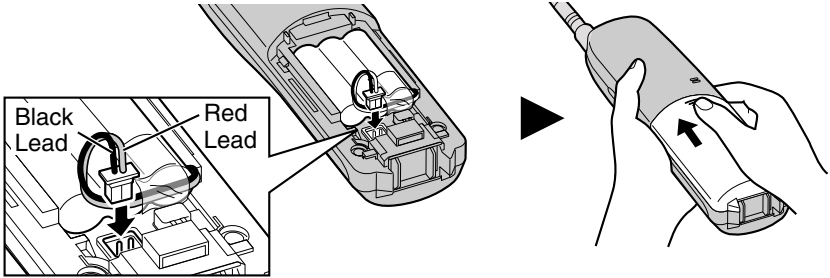

Battery Charge

Place the handset on the base unit and charge for about **10 hours** before initial use.

- The IN USE/CHARGE indicator lights and a beep sounds.

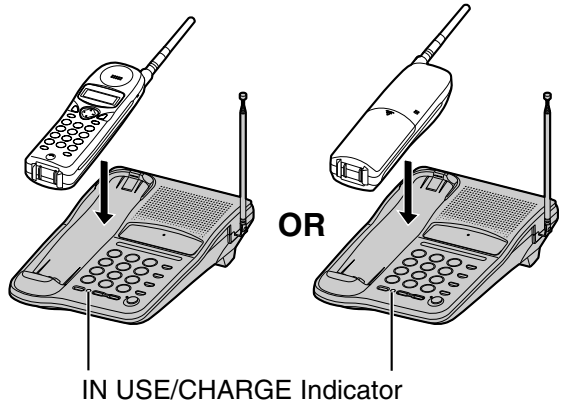

Battery strength

You can check the battery strength on the handset display while the handset is on the base unit, while it is in use (making/answering a call etc.), or after viewing the Caller List or directory items, programming etc. The battery strength will remain for a few seconds after using the handset, then the display will return to the standby mode (p. 13).

The battery strength is as shown in the chart below.

Display prompt	Battery strength
{ ■■■ }	Fully charged
{ ■■ }	Medium
{ ■ }	Low
{ ■ } (flashing)	Needs to be recharged.



Recharge

Recharge the battery when:

- “Recharge” is displayed on the handset,
- “{ ■}” flashes on the display, or
- the handset beeps intermittently while it is in use.

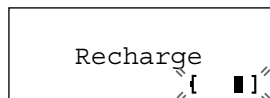

- If you DO NOT recharge the handset battery for more than 30 minutes, the display will keep indicating “Recharge” and/or “{ ■}” will continue to flash.
- To fully recharge the battery, the handset should be left on the base unit for 10 hours.

Battery information

After your Panasonic battery is fully charged (p. 12):

Operation	Operating time
While in use (TALK)	Up to about 8 hours
While not in use (Standby)	Up to about 20 days

- The battery operating time may be shortened depending on usage conditions, such as viewing the Caller ID Caller List or directory list, and ambient temperature.
- Clean the handset and the base unit charge contacts with a soft, dry cloth once a month. Clean more often if the unit is subject to grease, dust or high humidity.** Otherwise the battery may not charge properly.
- If the battery is fully charged, you do not have to place the handset on the base unit until “Recharge” is displayed and/or “{ ■}” flashes. This will maximize the battery life.
- The battery cannot be overcharged.

Standby mode (While the handset is off the base unit)

The handset goes into the standby mode after you finish using the handset (making/answering a call, viewing the Caller List or directory list etc.). The display is blank, but the handset can receive calls. The battery operating time is conserved in this mode.

Time and Date Adjustment

You can select AM/PM or 24-hour clock by programming.

Make sure the unit is in the standby mode initially.

- 1 Lift the handset off the base unit and press \ominus / **(EXIT/CH)** twice.
OR
When the handset is off the base unit, press \ominus / **(EXIT/CH)** once.
 - If previously adjusted, "Adjust" will be displayed on the third line.
- 2 Press \blacktriangleright (Set clock key).
 - You may press \blacktriangleright (Adjust key) instead.
- 3 Enter the current year by using a 4-digit number.
(Ex. To set the year 2001, enter "2001".)
- 4 Press \blacktriangleright (Next key).
- 5 Enter the current time (hour and minute) by using a 4-digit number.
(Ex. To set 9:30, enter "0930".)
 - For AM/PM setting: Enter numbers between 0100 and 1259.
 - For 24-hour clock: Enter numbers between 0000 and 2359.
- 6 Press \blacktriangleright (Next key).
 - If numbers between 0000 and 0059, or 1300 and 2359 are entered, the time will automatically be set using the 24-hour clock. Skip the steps 7 and 8 and go to the step 9.
- 7 Press \star to select "AM" or "PM" or 24-hour clock. (Ex. You select "PM".)

```
12:00A  1.1
                0000
                ►=Set clock
```

```
12:00A 01.01
Enter year 0000
                ►=Next
```

```
12:00A 01.01
Enter year 2001
                ►=Next
```

```
12:00A 01.01
Enter time
                ►=Next
```

```
09:30A 01.01
Enter time
                ►=Next
```

```
09:30A 01.01
* =AM/PM
                ►=Next
```

```
09:30P 01.01
* =AM/PM
                ►=Next
```

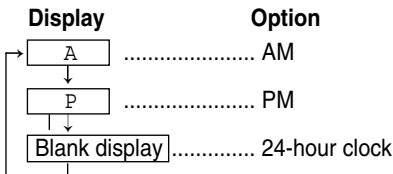

•Each time you press \star , the selection will change on the display.

8 Press  (Next key).

09:30P 01.01
Enter day.month
▶=Save

9 Enter the current date by using a 4-digit number.
(Ex. To set Dec. 27, enter "2712".)

09:30P 27.12
Enter day.month
▶=Save

10 Press  (Save key).
•A beep sounds.
•The clock starts working.

09:30P 27.12
2001

- You can go back to the previous display by pressing , when setting the time and date.
- If 3 beeps sound when entering the time and date, a wrong number was entered. Enter the correct time and date.

To check the time and date

You can check the current time and date in the standby mode.

Lift the handset off the base unit and press  **EXIT/CH** twice.

OR

When the handset is off the base unit, press  **EXIT/CH** once.

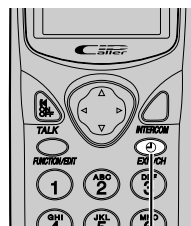

 **EXIT/CH**

- The current time and date is displayed for 30 seconds.
To return to the standby mode, press  **EXIT/CH**.

If a power failure occurs, you have to readjust the time and date. If you use the handset for making/answering calls or remote operation without adjusting the time and date, the display in step 1 appears for 5 seconds after "Off" is displayed.

For Caller ID service users (p. 27)

- The Caller ID information will re-set the clock after the first ring if the adjusted time and/or date is incorrect. However, if the time has not previously been set, the Caller ID information will not adjust the clock.
- The caller ID information will automatically adjust the clock for daylight saving time.

Programmable Functions

You can program the following functions **by using the handset near the base unit**. The display shows the programming instructions. See the corresponding pages for function details.

Make sure the unit is in the standby mode initially.

Lift the handset, and press **FUNCTION/EDIT**.



<Function menu>*

▶Save directory.....	To store an item in the directory (p. 38).
Ringer volume	To select the ringer volume (p. 18).
Program	

Press **▶**.

<Function menu>*

▶LCD contrast.....	To select the LCD contrast (p. 19).
Set recall	To select the recall time (p. 49).
Talk switching.....	To set the auto talk feature (p. 17).
Set area code	To set your area code (p. 20).

During programming:

- *To select a desired function, press **▼** or **▲** repeatedly until the arrow points to the item. Then press **▶** to go to the next step.
- You can exit the programming mode any time by pressing **EXIT/CH**.
- If you do not press any buttons for 60 seconds, the unit will return to the standby mode.



Setting the Auto Talk Feature

The Auto Talk feature allows you to answer a call by lifting the handset off the base unit without pressing **TALK**. If you want to use this feature, you need to enable this feature. Your phone comes from the factory set to OFF.

Make sure the unit is in the standby mode initially.

1 Press **FUNCTION/EDIT**.

2 Press **▼** or **▲** repeatedly until the arrow points to "Program".

```

▶Program
▼▲           ▶=Yes
  
```

3 Press **▶** (Yes key).

4 Press **▼** or **▲** repeatedly until the arrow points to "Talk switching".

```

▶Talk switching
  Set area code
▼▲           ▶=Yes
  
```

5 Press **▶** (Yes key).

```

Auto talk
                :Off
▼▲           ▶=Save
  
```

6 Press **▼** or **▲** to select "On" or "Off".

```

Auto talk
                :On
▼▲           ▶=Save
  
```

7 Press **▶** (Save key).

- A beep sounds.
- To return to the standby mode, press **EXIT/CH**.

```

Auto talk
                :On
  
```

- You can exit the programming mode any time by pressing **EXIT/CH**.
- In order to view Caller ID information before answering a call, leave the Auto Talk feature OFF.

➡ Programmable Functions

Selecting the Ringer Volume

You can set the handset and base unit ringer volumes to HIGH, LOW or OFF. If set to OFF, the handset/base unit will not ring. Your phone comes from the factory set to HIGH.

With the handset

Make sure the unit is in the standby mode initially.

- 1 Press **FUNCTION/EDIT**.
- 2 Press **▼** or **▲** repeatedly until the arrow points to "Ringer volume" and press **▶** (Yes key).
- 3 Press **▼** or **▲** to select the desired volume.
 - The selected volume is displayed and rings.
 - To turn the ringer OFF, press and hold **▼** until 2 beeps sound.

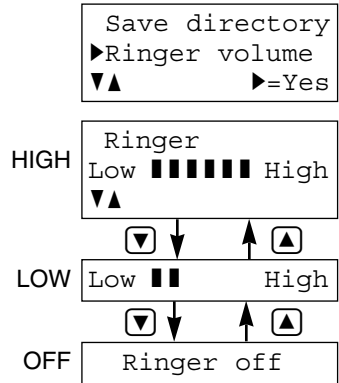

To turn the ringer ON, press **▲** or **▼** in step 3.

- The ringer will sound at the LOW level.
- You can also select the ringer volume while a call is being received. Press **▼** or **▲** while the unit is ringing.
- When set to OFF, "Ringer off" will flash for about 45 seconds before the handset returns to the standby mode.

With the base unit

Make sure the unit is in the standby mode initially. (You can also select the ringer volume while a call is being received.)

To select HIGH or LOW, press **HOLD/RINGER**. Each time you press the button, the ringer volume will change and the selected ringer volume will ring.

To turn the ringer OFF, press and hold **HOLD/RINGER** until 2 beeps sound.

To turn the ringer ON, press **HOLD/RINGER**.

- The ringer will sound at the HIGH level.

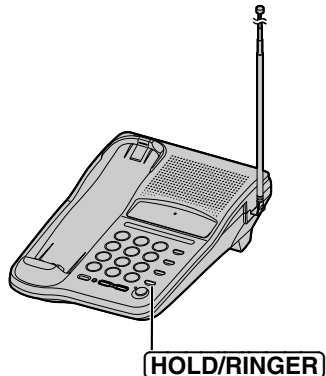



Setting the LCD Contrast

You can program the handset LCD contrast (5 levels). To make the handset display clearer, set to high level. Your phone comes from the factory set to level 3.

Make sure the unit is in the standby mode initially.

1 Press **FUNCTION/EDIT**.

2 Press or repeatedly until the arrow points to "Program".

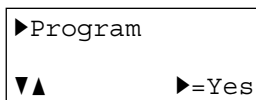

3 Press (Yes key).

4 While the arrow points to "LCD contrast", press (Yes key).

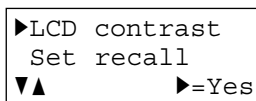

5 Press or to select the desired contrast.

- Each time you press or , the LCD contrast will change.



6 Press (Save key).

- A beep sounds.
- To return to the standby mode, press **EXIT/CH**.

- You can exit the programming mode any time by pressing **EXIT/CH**.

➡ Programmable Functions

Storing Your Area Code

We recommend you program your area code before using the Caller ID feature (p. 27). Incoming calls from the same area will be then recorded in the Caller List without the area code. You do not have to remove the code before calling back or storing.

Make sure the unit is in the standby mode initially.

To store your area code

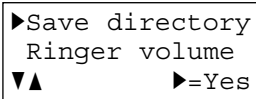
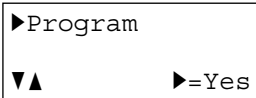
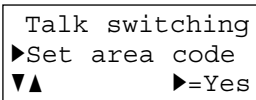
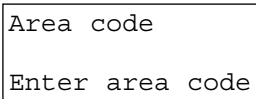
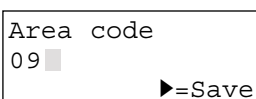
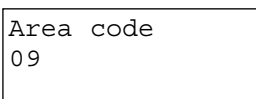
- 1 Press **FUNCTION/EDIT**.

- 2 Press **▼** or **▲** repeatedly until the arrow points to "Program", and press **▶** (Yes key).

- 3 Press **▼** or **▲** repeatedly until the arrow points to "Set area code".

- 4 Press **▶** (Yes key).
 - If previously set, the current area code is displayed.
- 5 Enter your area code.
 - You can enter the number up to 8 digits.
 - If you enter a wrong number, press **◀**. The digits are erased from the right.
- 6 Press **▶** (Save key).
 - A beep sounds.
 - To return to the standby mode, press **EXIT/CH**.

•You can exit the programming mode any time by pressing **EXIT/CH**.

To erase your area code

Press **FUNCTION/EDIT** ➡ **▼** or **▲** to select "Program" ➡
➡ **▶** (Yes key) ➡ **▼** or **▲** to select "Set area code" ➡
➡ **▶** (Yes key) ➡ ***** ➡ **▶** (Save key).

For New Zealand Users:

Your telephone company may charge you for a local call if the number dialled has the area code prefix included. If the charge for local call is unacceptable, store your area code as shown above before use, or only the 7-digits of the local number should be dialled from your telephone. Do not dial the "0" prefix or the area code digit.

Making Calls



With the Handset

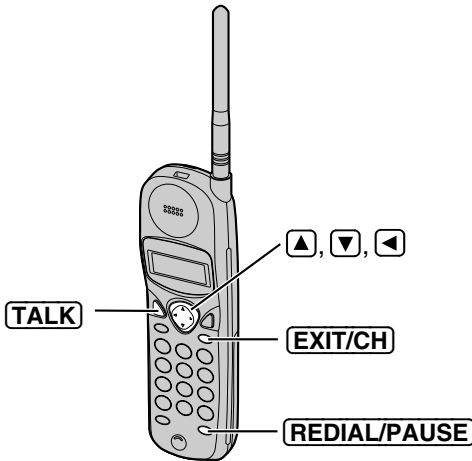

1 Press **TALK**.



2 Dial a phone number.

- The dialled number is displayed.
- After a few seconds, the display will show the length of the call and the battery strength.

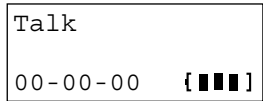
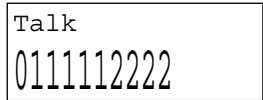

3 To hang up, press **TALK** or place the handset on the base unit.



•If the handset has lost communication with the base unit, 3 beeps sound and “No link to base Place on cradle and try again.” is displayed.

If noise interferes with the conversation

Press **EXIT/CH** to select a clearer channel or move closer to the base unit.

To redial the last number dialled on the handset

Press **TALK** and press **REDIAL/PAUSE**.

➔ Making Calls

To dial after confirming the entered number



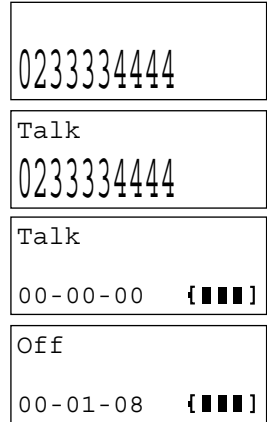

- 1 Dial a phone number.
 - If you misdial, press  and dial again.
- 2 Press **TALK**.
 - After a few seconds, the display will show the length of the call and the battery strength.
- 3 To hang up, press **TALK** or place the handset on the base unit.



To redial after confirming the last number dialed

Press **REDIAL/PAUSE** and press **TALK**.

To adjust the receiver volume while talking

- To increase, press .
- To decrease press .
- Each time you press  or , the volume level will change.
 - The display will return to the length of the call.

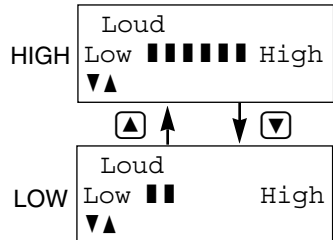

Backlit handset keypad

The handset dialling buttons will light when you press a button or lift the handset off the base unit, or flash when a call is received.

The lights will turn off a few seconds after pressing a button, lifting the handset, answering a call, hanging up a call, leaving the programming mode or ending the intercom.

Backlit LCD display

The backlit handset display will stay on for a few seconds after pressing a handset button, lifting the handset off the base unit, hanging up a call, leaving the programming mode or ending the intercom.



With the Base Unit (Digital Duplex Speakerphone)

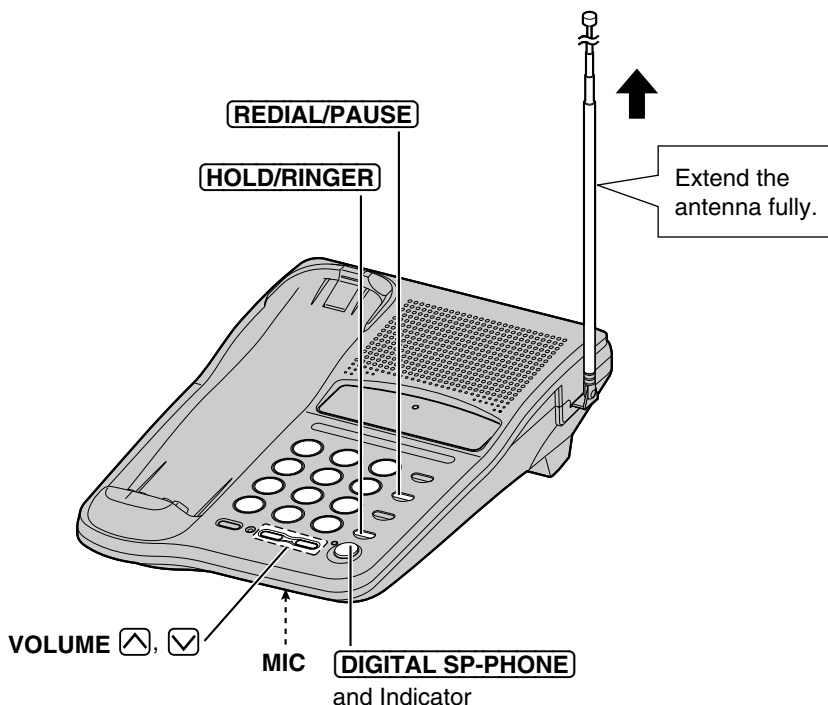

- 1 Press **DIGITAL SP-PHONE**.
 - The DIGITAL SP-PHONE indicator lights.
- 2 Dial a phone number.
- 3 When the other party answers, talk into the **MIC** (microphone).
- 4 To hang up, press **DIGITAL SP-PHONE**.
 - The indicator light goes out.

- To switch to the handset while using the base unit speakerphone:
 - If the handset is off the base unit, press **TALK**.
 - If on the base unit, just lift up.
- During a call using the handset, the call can be switched to the speakerphone by pressing **DIGITAL SP-PHONE**.

➡ Making Calls

Hands-free Digital Duplex Speakerphone

For best performance, please note the following:

- Talk alternately with the caller in a quiet room.
- If the other party has difficulty hearing you, press **VOLUME** to decrease the speaker volume.
- If the other party's voice from the speaker cuts in/out during a conversation, press **VOLUME** to decrease the speaker volume.

To adjust the speaker volume (8 levels) while talking

To increase, press **VOLUME** .

To decrease, press **VOLUME** .

To redial the last number dialed on the base unit

Press **DIGITAL SP-PHONE** and press **REDIAL/PAUSE**.

To put a call on hold

Press **HOLD/RINGER**.

- The DIGITAL SP-PHONE indicator flashes.
- When using the handset during a call, you can also put a call on hold by pressing **HOLD/RINGER** on the base unit.

To release the hold

From the base unit, press **DIGITAL SP-PHONE**.

From the handset, press **TALK** or lift the handset off the base unit.

- If another phone is connected on the same line (p. 53), you can also release the held call by lifting its handset.

Simultaneous Keypad Dialling

You can use the base unit like a standard telephone. After pressing **TALK** to make a call with the handset near the base unit, you can also dial using the base unit keypad.

- 1 Handset:
Press **TALK**.
- 2 Base unit:
Dial a telephone number while hearing a dial tone on the handset.
 - When the other party answers, talk using the handset.
- 3 Handset:
To hang up, press **TALK** or place the handset on the base unit.



Simultaneous Keypad Dialling is only possible after pressing **TALK**.

Useful information

You can enter numbers using the base unit keypad during a call with the handset. For example, to access an answering service, electronic banking service, etc.

1. Handset:
Press **TALK**.
2. Handset:
Dial a telephone number.
 - You can also dial with the base unit keypad.
3. Base unit:
Enter the required numbers while listening to the pre-recorded instructions.
4. Handset:
To hang up, press **TALK** or place the handset on the base unit.

Answering Calls

When a call is received, the unit rings, "Incoming call" is displayed on the handset and the CALLER ID indicator flashes quickly.

If you subscribe to a Caller ID service, the calling party information will be displayed after the first ring (p. 27). In order to view the Caller ID information, please wait until the second ring to answer a call.

With the Handset

If the handset is off the base unit, press **TALK**.

- You can also answer a call by pressing any dialing button **0** to **9**, ***** or **#** (**—Any Key Talk**).



Auto Talk

If you set the Auto Talk feature to ON (p. 17), you can answer a call by lifting the handset off the base unit without pressing **TALK**.

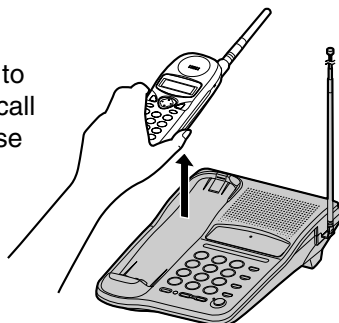

With the Base Unit (Digital Duplex Speakerphone)

- 1 Press **DIGITAL SP-PHONE**.
- 2 Talk into the **MIC**.
- 3 To hang up, press **DIGITAL SP-PHONE**.

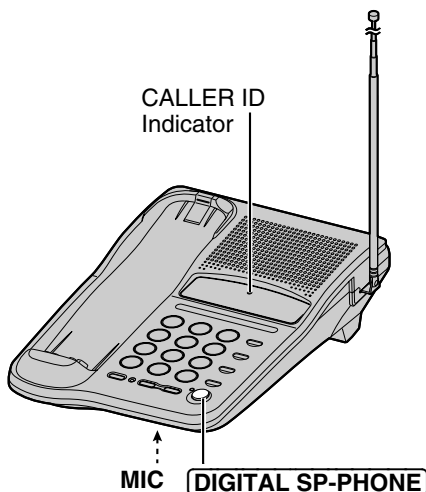

Caller ID Service



This unit is compatible with a Caller ID service offered by your telephone company. If you subscribe to a Caller ID service, the calling party's information will be shown on the handset display after the first ring.

The unit can store up to 50 different callers in the Caller List. The Caller List information is sorted by the most recent to the oldest call. When the 51st call is received, the information of the first call is replaced with the information of the 51st call.

Using the list, you can automatically call back a caller. You can store the callers' phone numbers from the Caller List into the directory.

When a second call is received while talking, the new caller's phone number will be displayed (**for Australia only**) (p. 48).

How caller information is displayed when a call is received

The handset display shows the caller's phone number after the first ring.*

- After you answer the call, the display will show the length of the call.

0244448888

(The number is an Australian example.)

The CALLER ID indicator light will flash quickly when a call is being received.

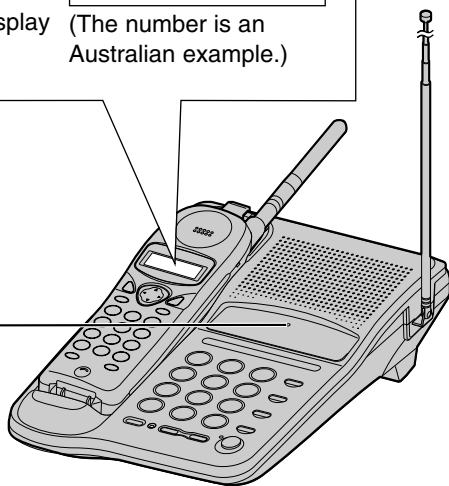

*Private name display

If you receive a call from one of the same phone numbers stored in the directory, the caller's name will be displayed.

- To use this function, names and phone numbers must be stored in the directory (p. 37).

TINA ROBINSON
0244448888

➔ Caller ID Service

- Caller information cannot be displayed in the following cases:
 - If the caller dialed from an area which does not support Caller ID service, the display will show “Out of area”.
 - If the caller has requested not to display his/her information, the display will show “Private caller”.
 - If your unit is connected to a PBX which does not support Caller ID services, you cannot access those services.
 - If the name display service is available in your area, the display will show callers' names.
- For further information, please contact your telephone company.
- If you receive a call with the Caller ID information while viewing the Caller List or while in the intercom mode, the caller's information may not be displayed.

For New Zealand Users:

Your telephone company may not support the second caller display feature.

To check the number of new calls

When new calls have been received, the CALLER ID indicator flashes slowly on the base unit. The handset display shows the number of new calls.

While the handset is on the base unit:

If you have received 10 new calls, the display will show the following.

```
10 new calls
  {■■■■}
```

When you lift the handset, the display changes to the following.

```
10 new calls
▼=New    ▲=Old
```

- After 10 seconds, the display changes to the standby mode (p. 13).

While the handset is off the base unit:

Press ◀ or ▶ to turn the display on. If you have received 10 new calls, the display will show the following:

```
10 new calls
▼=New    ▲=Old
```

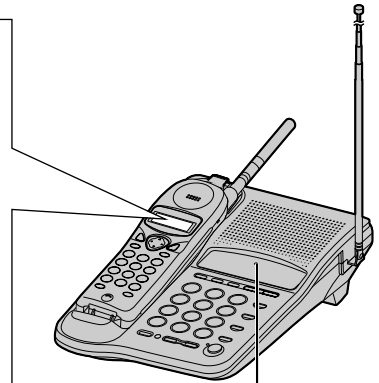

CALLER ID Indicator

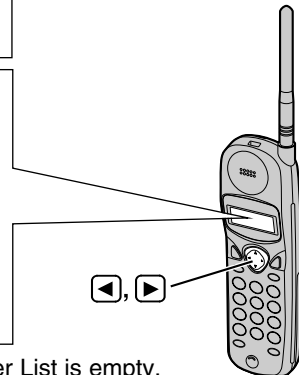

- If “No items stored” is displayed, the Caller List is empty.

Using the Caller List



Viewing the Caller List

To check who has called, follow the steps below.

Make sure the unit is in the standby mode initially.

- 1** Lift the handset off the base unit.
OR

If the handset is off the base unit, press or to enter the list.

- The display will show, for example, the following.

```
2 new calls
▼=New      ▲=Old
```

- 2** To search from the most recent call, press .

To search from the oldest call, press .

- To scroll between callers, press or .

- 3** To exit the list, press **EXIT/CH**.

- The handset will return to the standby mode.

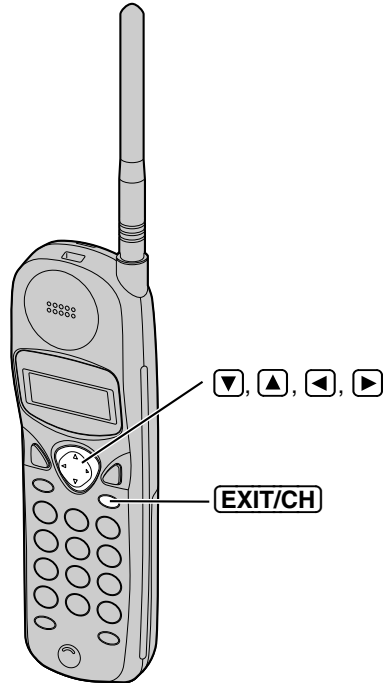

- Once new calls have been checked, “√” will be added.
- If “Caller's list No items stored” is displayed in step 1, the Caller List is empty.
- If more than one call is received from the same caller, the date and time of the last call will be recorded. If the same caller calls again, the call entry with “√” will be deleted.

➡ Using the Caller List

Ex. When you search from the most recent call:

Lift the handset off the base unit.

OR

If the handset is off the base unit, press ◀ or ▶.

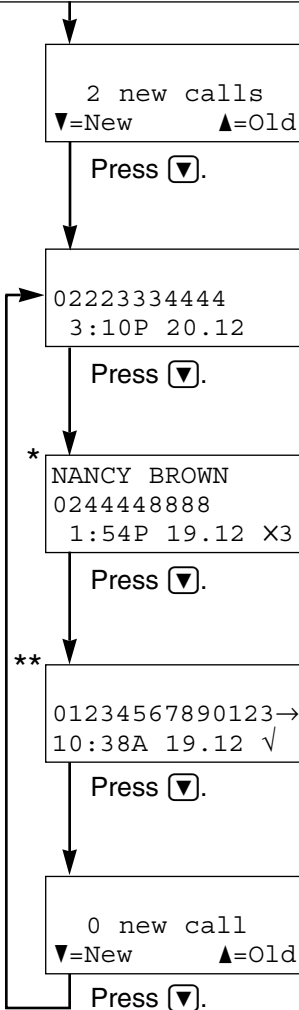

To return to the previous caller, press ▲.

To exit the Caller List, press **EXIT/CH**.

- The handset will return to the standby mode.

*If you receive a call from one of the same phone numbers stored in the directory, the caller's name will be displayed (**Private name display**).

**If an arrow (→) is displayed after the number, the whole phone number has not been shown.

Press # (→) to see the remaining numbers or * (←) to return to the previous display.

Display meaning:

✓ : You have checked this caller information, answered the call or, called back the caller.

x2 - x9 : The number of times the same caller called (up to 9).
After checking, "x2" - "x9" will be replaced with "✓".



Calling Back from the Caller List

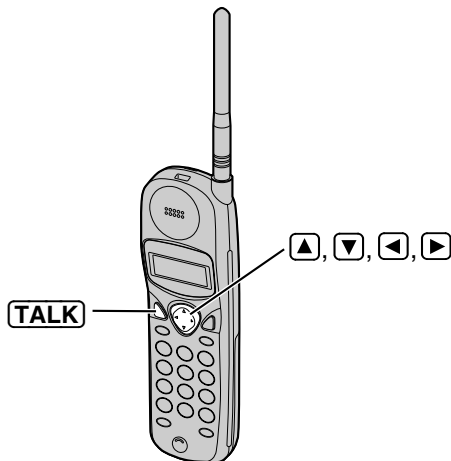

- 1 Lift the handset off the base unit.
OR
If the handset is off the base unit, press ◀ or ▶ to enter the list.

```

3 new calls
▼=New      ▲=Old
  
```

- 2 Press ▼ or ▲ repeatedly to find the desired caller.

```

0355566677
11:20A 20.12 X3
  
```

- 3 Press **TALK**.
 - The displayed phone number is dialed automatically.

```

Talk
0355566677
  
```

```

Talk
00-00-00 [■■■■]
  
```

•If a phone number is not displayed in the caller information, you cannot call back that caller.

For New Zealand Users:

Your telephone company may charge you for a local call if the number dialled has the area code prefix included. If the charge for local call is unacceptable, only the 7-digits of the local number should be dialled from your telephone. Do not dial the "0" prefix or the area code digit.

➔ Using the Caller List

Editing the Caller's Phone Number

You can edit a phone number in the Caller List. After editing the number, you can continue with calling back or directory storing procedures.

Make sure the unit is in the standby mode initially.

- 1 Lift the handset off the base unit.
OR
If the handset is off the base unit, press ◀ or ▶ to enter the list.

5 new calls
▼=New ▲=Old

- 2 Press ▼ or ▲ repeatedly to find the desired caller.

0355566677
11:20A 20.12 ✓

- 3 **To add a number**
Add a number to the current number using the dialling buttons (0 to 9).

•If you misdial, press ◀ and dial again.

To erase the number

Press **FUNCTION/EDIT**, then press ◀ to erase the digit.

•You can also add a number if required.

- 4 After editing the number, you can continue with calling back or storing procedures.

To call back, press **TALK** (p. 31).

To store the number in the directory, press ▶ and follow the instructions on the display (see page 33, from step 3).

- If the phone number does not include the area code (which is the same as your area code, p. 20), you can view the original number (area code + phone number) by pressing **FUNCTION/EDIT** again in step 3.
- The number edited in step 4 will not be maintained in the Caller List.

For New Zealand Users:

Your telephone company may charge you for a local call if the number dialled has the area code prefix included. If the charge for local call is unacceptable, only the 7-digits of the local number should be dialled from your telephone. Do not dial the "0" prefix or the area code digit.



Storing Caller List Information in the Directory

You can store names and phone numbers that are in the Caller List into the directory. **Storing must be carried out with the handset.**

Make sure the unit is in the standby mode initially.

- 1 Lift the handset off the base unit.
OR
If the handset is off the base unit, press or to enter the list.

```

10 new calls
▼=New      ▲=Old

```

- 2 Press or repeatedly to find the caller you want to store in the directory, and press .

```

0355566677
11:20A 20.12 X3

```

- 3 Press or to select "Save directory", and press (Yes key).

```

▶Save directory
Clear
▼▲              ▶=Yes

```

When the caller's name is not displayed in the Caller List:

- a) If a name is not required, press (Save key).
- b) If a name is required, enter the name (p. 39). When finished, press (Save key).

```

Enter name
█
*#=←→          ▶=Save

```

```

Enter name
CINDY TURNER
*#=←→          ▶=Save

```

- A beep sounds.
- To continue storing other items, repeat from step 2.
- To return to the standby mode, press **EXIT/CH**.

```

CINDY TURNER
0355566677

```

- You can exit the programming mode any time by pressing **EXIT/CH**.
- If the display shows "Memory is full" in step 3, press **EXIT/CH** to exit the list. To erase other stored items from the directory, see page 44.
- After the maximum of 30 items has been stored, "Memory is full" is also displayed.
- You cannot store caller information in the directory if a phone number is not displayed.

➔ Using the Caller List



For New Zealand Users:

Your telephone company may charge you for a local call if the number dialled has the area code prefix included. If the charge for local call is unacceptable, only the 7-digits of the local number should be dialled from your telephone. Do not dial the “0” prefix or the area code digit.



Erasing Caller List Information

After checking the Caller List, you can erase some or all of the entries. **Make sure the unit is in the standby mode initially.**



To erase a specific caller from the Caller List

- 1 Lift the handset off the base unit.
OR
If the handset is off the base unit, press  or  to enter the list.

```
10 new calls
▼=New      ▲=Old
```

- 2 Press  or  repeatedly to find the caller you want to erase from the Caller List, and press .

```
0246813579
12:20A 20.12 ✓
▶Save directory
Clear
▼▲                ▶=Yes
```

- 3 Press  or  to select “Clear”, and press  (Yes key).
- A beep sounds and the information is erased.
 - To erase other items, repeat from step 2.
 - To return to the standby mode, press **EXIT/CH**.

```
Save directory
▶Clear
▼▲                ▶=Yes
```

```
Clear
```

To erase all entries in the Caller List

Before erasing all entries, make sure that "0 new call" is displayed.

- 1 Lift the handset off the base unit.
OR
If the handset is off the base unit,
press ◀ or ▶ to enter the list.

```
0 new call
▼=New      ▲=Old
```

- 2 Press ▶ (Yes key).

```
▶Exit
All clear
▼▲          ▶=Yes
```

- 3 Press ▼ or ▲ to select "All clear".

```
Exit
▶All clear
▼▲          ▶=Yes
```

- 4 Press ▶ (Yes key).
•A beep sounds and all entries are erased.

```
All clear
```

Speed Dialler

Storing Phone Numbers in Memory

You can store up to 10 numbers in the base unit. The dialling buttons (0) to (9) function as memory stations.

Make sure the unit is in the standby mode initially.

- 1 Press **AUTO/PROGRAM**.
 - The IN USE/CHARGE indicator flashes.

- 2 Enter a phone number up to 22 digits.
 - If you misdial, press **AUTO/PROGRAM** twice to end storing and start again from step 1.

- 3 Press **AUTO/PROGRAM**.

- 4 Press a memory station number (0) to (9).
 - A beep sounds.
 - To store other numbers, repeat steps 1 through 4.

- If a pause is required for dialling, press **REDIAL/PAUSE** where needed. Pressing **REDIAL/PAUSE** counts as one digit (p. 47).

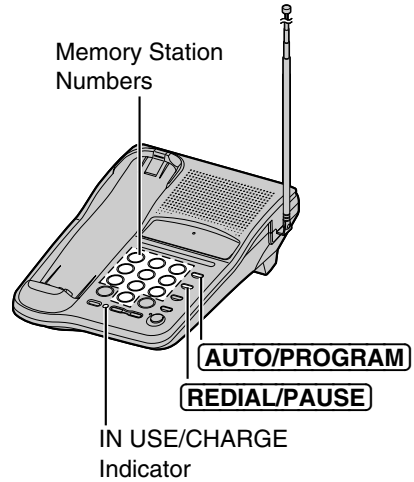

To erase a stored number

Press **AUTO/PROGRAM** twice ➔ the memory station number (0) to (9) for the phone number to be erased.

Dialling a Stored Number

- 1 Press **DIGITAL SP-PHONE**.

- 2 Press **AUTO/PROGRAM**.

- 3 Press the memory station number (0) to (9).
 - The stored number is dialled.

- Numbers stored can only be dialled by the base unit.

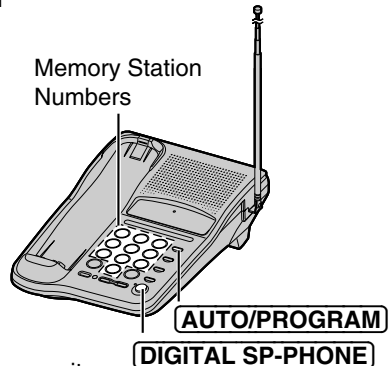

Using the Directory



You can store up to 30 names and phone numbers in the directory using the handset. All directory items are sorted by the first word in alphabetical order. Using the directory, you can make a call by selecting a name on the handset display. When you receive a caller ID call from a caller stored in the directory, the display will show the caller's name with the phone number (—**Private name display**) (p. 27).

Storing Names and Numbers in the Directory

Make sure the unit is in the standby mode initially.

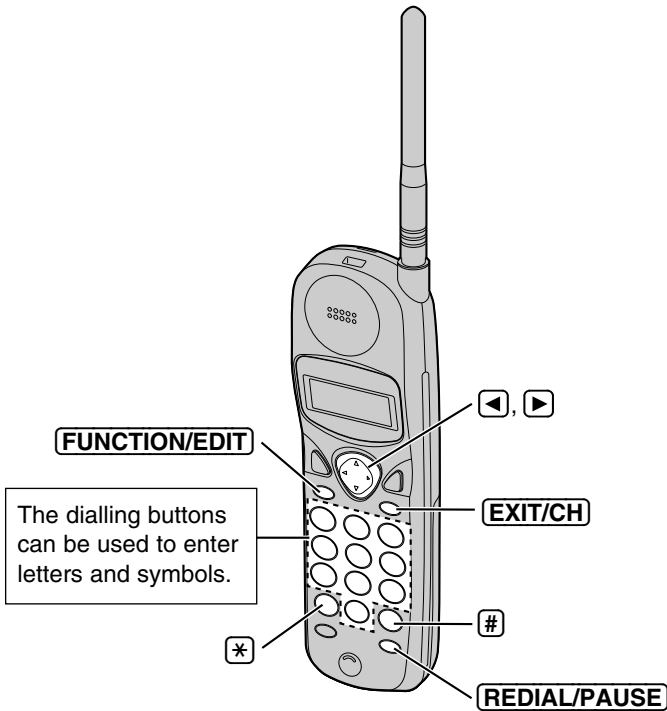

(Continued→)

➡ Using the Directory

1 Press **FUNCTION/EDIT**.

▶Save directory
Ringer volume
▼▲ ▶=Yes

2 While the arrow points to “Save directory”, press **▶** (Yes key).
•The display shows the number of stored items in the directory.

Directory=
20 items

3 Enter a name, up to 15 characters using the dialling buttons (p. 39).
•To move the cursor, press *** (←)** or **# (→)**.
•If a name is not required, press **▶** (Next key) and go to step 5.

Enter name
█
*#=←→ ▶=Next

Enter name
Tom Jones
*#=←→ ▶=Next

4 Press **▶** (Next key).

Enter phone no.

5 Enter a phone number, up to 22 digits.
•If you misdial, press **◀**. Digits are erased from the right.

03987654321

▶=Save

6 Press **▶** (Save key).
•A beep sounds.
•To continue storing other items, repeat from step 2.
•To return to the standby mode, press **EXIT/CH**.

Tom Jones
0987654321

- If a pause is required for dialling, press **REDIAL/PAUSE** to add a pause to a phone number in step 5. This counts as one digit (p. 47).
- You can exit the programming mode any time by pressing **EXIT/CH**.
- If the display shows “Memory is full” in step 2, press **EXIT/CH**. To erase other stored items from the directory, see page 44.
- After the maximum of 30 items has been stored, “Memory is full” is also displayed.

For New Zealand Users:

Your telephone service provider may charge you for a local call when it is dialled with an area code prefix. If the charge for local call is unacceptable, only the 7-digits of the local number should be dialled from your telephone. Do not dial the “0” prefix or the area code digit.



Selecting Characters to Enter Names

The handset dialling buttons can be used to enter letters and symbols. The letters are printed on the dialling buttons.

Pressing each button selects a character as shown below.

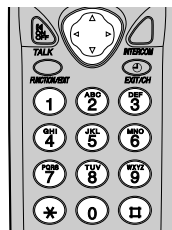

Keys	Number of times key is pressed										
	1	2	3	4	5	6	7	8	9	10	11
1	#	&	'	()	*	,	-	.	/	1
2	A	B	C	a	b	c	2				
3	D	E	F	d	e	f	3				
4	G	H	I	g	h	i	4				
5	J	K	L	j	k	l	5				
6	M	N	O	m	n	o	6				
7	P	Q	R	S	p	q	r	s	7		
8	T	U	V	t	u	v	8				
9	W	X	Y	Z	w	x	y	z	9		
0	0	Blank									
*	To move the cursor to the left										
#	To move the cursor to the right										



•To enter another character using the same dialling button, press # to move the cursor to the next space.

If you make a mistake while entering a name

Use * (←) or # (→) to move the cursor to the incorrect character, press ◀ to delete, and re-enter the correct character. Each time you press ◀, a character is erased from the right.

➡ Using the Directory

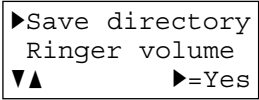
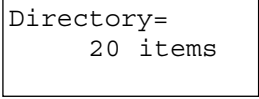
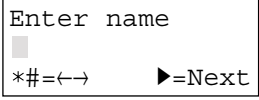
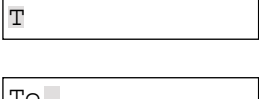
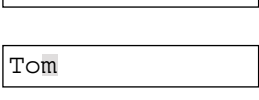
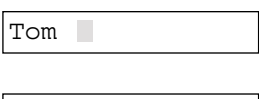
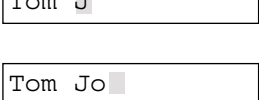
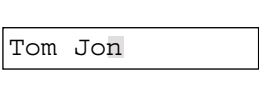
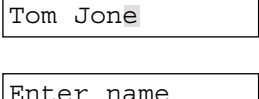
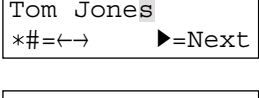
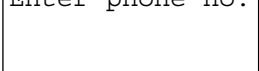
For example, to enter “Tom Jones”:

- 1 Press **FUNCTION/EDIT**.

- 2 While the arrow points to “Save directory”, press **▶** (Yes key).

- 3 Press **8**.

- 4 Press **6** six times, then press **#** to move the cursor to the right.

- 5 Press **6** four times.

- 6 Press **#** twice to enter a blank.

- 7 Press **5**.

- 8 Press **6** six times, then press **#** to move the cursor to the right.

- 9 Press **6** five times.

- 10 Press **3** five times.

- 11 Press **7** eight times.

- 12 When finished, press **▶** (Next key).
 - To enter a phone number and continue storing, see page 38, from step 5.



Finding Items in the Directory

You can search the directory using the handset.

Make sure the unit is in the standby mode initially.

1 Press or to enter the directory list.

- The first item is displayed.

Ann
0312345678

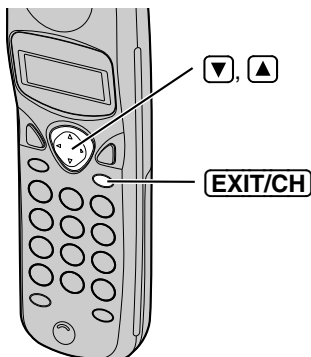

2 Press or repeatedly until the desired item is displayed.

- All directory items are stored in the order shown on the right.

To search for a name by initial

- ① Press the dialling button for the first letter of the desired name until any name with the same initial is displayed (see the Index table on page 42).
Ex. To find "Frank", press **3** repeatedly until the first item under "F" is displayed.
- ② Press repeatedly until the name is displayed.

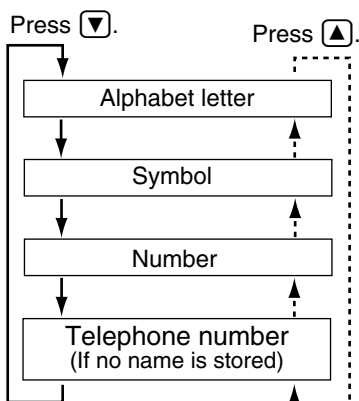

Advanced Operation

- You can leave the directory list any time by pressing **EXIT/CH**.
- If "Directory list No items stored" is displayed in step 1, the directory is empty.

➡ Using the Directory

Index table

Keys	Index	Keys	Index
①	Other symbols, 1	⑥	M, N, O, 6
②	A, B, C, 2	⑦	P, Q, R, S, 7
③	D, E, F, 3	⑧	T, U, V, 8
④	G, H, I, 4	⑨	W, X, Y, Z, 9
⑤	J, K, L, 5	⑩	0

Dialling from the Directory

Make sure the unit is in the standby mode initially.

- 1 Press **▼** or **▲** repeatedly to find the directory item that you want to dial.
 - To search for the item by initial, see page 41.
 - To exit the directory, press **EXIT/CH**.

Frank
0234567890

- 2 Press **TALK**.
 - The number is dialled automatically.

Talk
0234567890

- 3 To hang up, press **TALK** or place the handset on the base unit.

- Numbers stored can only be dialled by the handset.



Editing an Item in the Directory

Make sure the unit is in the standby mode initially.

- 1 Press or repeatedly to find the directory item you want to change, and press .

```
Jane
0233444555
```

- To search for the item by initial, see page 41.

- 2 While the arrow points to "Edit", press (Yes key).

```
▶Edit
  Clear
▼▲ ▶=Yes
```

- If you do not need to change the name, go to step 4.

- 3 Edit the name by using the dialling buttons, (←) or (→) (p. 39), up to 15 characters.

```
Enter name
Jane Walker
*#=←→ ▶=Next
```

- 4 Press (Next key).

- If you do not need to change the number, go to step 6.

```
0233444555
▶=Save
```

- 5 Add a number to the current number.

- Each time you press the digit to the left of the cursor is erased.

```
02333444555
▶=Save
```

- 6 When finished, press (Save key).

- A beep sounds.
- To continue editing other items, repeat from step 1.
- To return to the standby mode, press **EXIT/CH**.



```
Jane Walker
02333444555
```

- You can exit the programming mode any time by pressing **EXIT/CH**.

➡ Using the Directory

Erasing an Item from the Directory



Make sure the unit is in the standby mode initially.

- 1 Press  or  repeatedly to find the directory item you want to erase.
- To search for the item by initial, see page 41.

```
Helen
0357924680
```

- 2 Press .

```
▶Edit
  Clear
▼▲ ▶=Yes
```

- 3 Press  or  to select "Clear".

```
  Edit
▶Clear
▼▲ ▶=Yes
```

- 4 Press  (Yes key).
- A beep sounds and the item is erased.
 - To erase other items, repeat from step 1.
 - To return to the standby mode, press **EXIT/CH**.

```
Clear
```

- You can exit the programming mode any time by pressing **EXIT/CH**.

Intercom



A 2-way intercom is possible between the handset and the base unit.

Paging the base unit from the handset

- 1** Handset:
Press **INTERCOM**.
Talk to the paged party after the beeps.
•“Intercom” is displayed.
- 2** Base unit:
When the other party’s voice is heard, talk into the **MIC**.
- 3** Handset:
To end the intercom, press **INTERCOM**.



Paging the handset from the base unit (Handset locator)

Using this feature, you can locate a misplaced handset.

- 1** Base unit:
Press **LOCATOR/INTERCOM**.
•The handset beeps for 1 minute and “Press INTERCOM” is displayed.
•To stop paging, press **LOCATOR/INTERCOM** again.
- 2** Handset:
Press **INTERCOM** to answer.
•“Intercom” is displayed.
- 3** Base unit:
Talk into the **MIC**.
- 4** Handset:
To end the intercom, press **INTERCOM**.

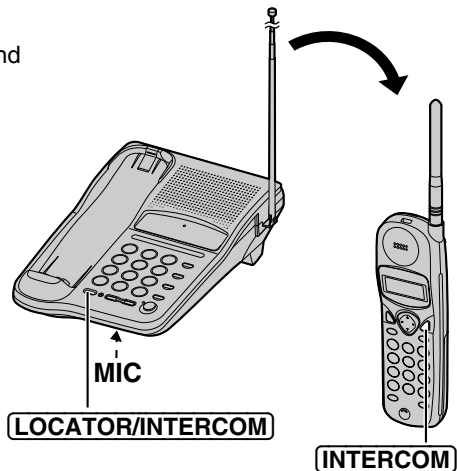

➡ Intercom

During an intercom call:

- Intercom calls can only be ended with the handset.
- If the handset user has difficulty hearing the base unit user, decrease the base unit speaker volume by pressing **VOLUME** .
- If an incoming call is received, the intercom call stops and the unit starts to ring. To answer, press **TALK** or **DIGITAL SP-PHONE**.

Transferring a Call Using the Intercom

The intercom can be used during a call. This feature enables you to transfer a call between the handset and the base unit.

From the handset to the base unit

- 1 Handset:
During a call, press **INTERCOM**. Talk to the paged party after the beeps.
 - The call is put on hold and “Intercom hold” is displayed.
 - If the base unit user does not answer, press **TALK**.
- 2 Base unit:
When the paging party’s voice is heard, talk into the **MIC**.
- 3 Base unit:
To answer the call, press **DIGITAL SP-PHONE**.
 - The transfer is complete.

From the base unit to the handset

- 1 Base unit:
During a call, press **LOCATOR/INTERCOM**.
 - The call is put on hold.
 - If the handset user does not answer, press **DIGITAL SP-PHONE**.
- 2 Handset:
Press **INTERCOM** to answer the page.
 - “Intercom hold” is displayed.
- 3 Handset:
To answer the call, press **TALK**.
 - The transfer is complete.

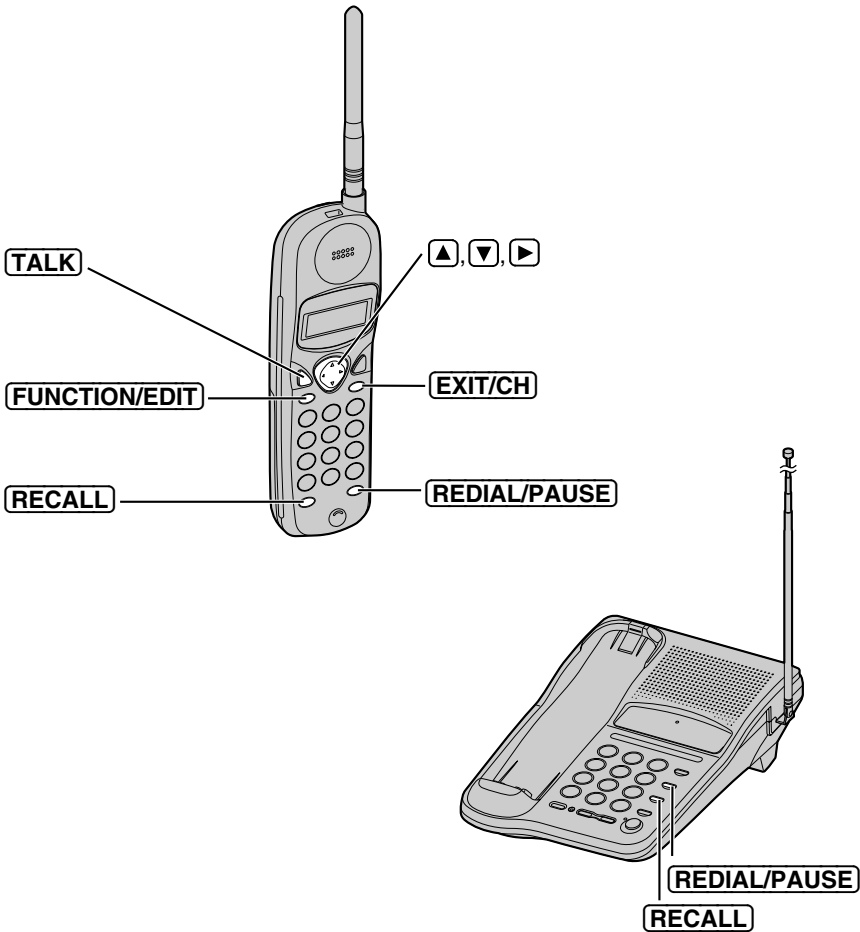

How to Use the PAUSE Button (For Analog PBX Line/Long Distance Service Users)

We recommend you press **REDIAL/PAUSE** if a pause is required for dialling with a PBX or to access a long distance service.

Ex. Line access number **9** (PBX)

9 → **REDIAL/PAUSE** → Phone number

- Pressing **REDIAL/PAUSE** once creates a 3.5 second pause. This prevents misdialling when you redial or dial a stored number.
- Pressing **REDIAL/PAUSE** more than once increases the length of the pause between numbers.

Automatic Security Code Setting

Each time you place the handset on the base unit, the unit automatically selects one of more than a million security codes. These codes help prevent the unauthorized use of your telephone line by another cordless telephone user.

Call Waiting and Caller ID Compatible (For Australia only)

If you subscribe to Caller ID services, your handset displays a second caller's information while talking. After you hear a call-waiting tone, the caller's phone number and "----Waiting-----" will be displayed.

0266667777 ----Waiting-----

You can answer the second call, keeping the first call on hold. Follow Telstra or your service provider instructions using **RECALL**.

- If the phone number is stored in the directory, the caller's name will be displayed (p. 27).
- When you receive a second call during a conversation, you will hear a signal tone following the call waiting tone and the conversation will be interrupted for approximately a second. The tones are generated from the telephone company. This is not fault of the product as these events are normal.
- The second caller's information will not be displayed when a parallel connected telephone is in use.
- Please contact Telstra or your service provider for details and availability in your area.

For Call Waiting Service Users in New Zealand

Make sure the recall time is set to 600 msec for use with Telecom's Call Waiting Service. Press **RECALL** if you hear a call-waiting tone while talking.

- The first call is put on hold and you can answer the second call.
- To return to the first caller, press **RECALL** again.
- Your telephone company may not support the second caller display feature.

RECALL Button

Pressing **RECALL** allows you to use special features of your host PBX such as transferring an extension call or accessing special telephone services (optional) such as call waiting.

Selecting the recall time

The recall time depends on your telephone exchange or host PBX. You can select the following recall times: “700, 600, 400, 300, 250, 110, 100 or 90 msec (milliseconds)”. KX-TC1220ALW comes from the factory set to “100 msec” and KX-TC1220NZW comes from the factory set to “600 msec”. **Make sure the unit is in the standby mode initially.**

1 Press **FUNCTION/EDIT**.

2 Press **▼** or **▲** repeatedly until the arrow points to “Program”.

```

▶Program
▼▲           ▶=Yes
  
```

3 Press **▶** (Yes key).

4 Press **▼** or **▲** repeatedly until the arrow points to “Set recall”.

```

LCD contrast
▶Set recall
▼▲           ▶=Yes
  
```

5 Press **▶** (Yes key).

6 Press **▼** or **▲** repeatedly until the desired time is displayed.

7 Press **▶** (Save key).

- A beep sounds.

- To return to the standby mode, press **EXIT/CH**.

- You can exit the programming mode any time by pressing **EXIT/CH**.

- Users in Australia can access Telstra’s “EASY CALL” service by having the recall time set at 100 msec (this is the factory default setting), and then follow Telstra’s “EASY CALL” instructions to operate this service.

- If you are connected via a PBX, a longer recall time may be necessary to use PBX functions (transferring a call etc.). Consult your PBX supplier for the correct setting.

For Call Waiting Service Users in New Zealand

Make sure the recall time is set to 600 msec for use with Telecom’s Call Waiting Service. Press **RECALL** if you hear a call-waiting tone while talking.

- The first call is put on hold and you can answer the second call.

- To return to the first caller, press **RECALL** again.

- Your telephone company may not support the second caller display feature.

Wall Mounting

This unit can be mounted on a wall.

- 1 Push the hook and turn it around.
Turn the hook until a click is heard.

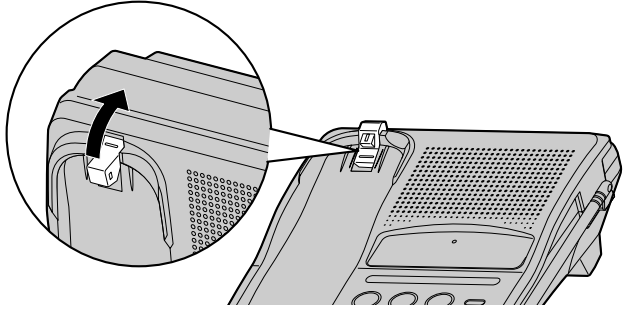

- 2 Connect the AC adaptor.

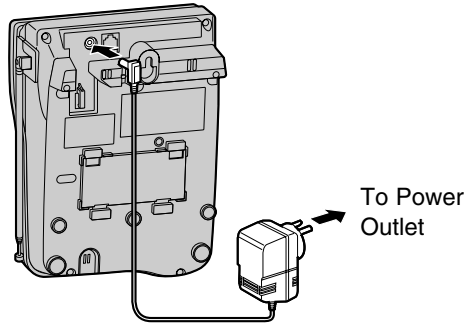

- 3 Tuck the telephone line cord inside the wall mounting adaptor, then push it in the direction of the arrow.
 - The word "UP" should face upward.

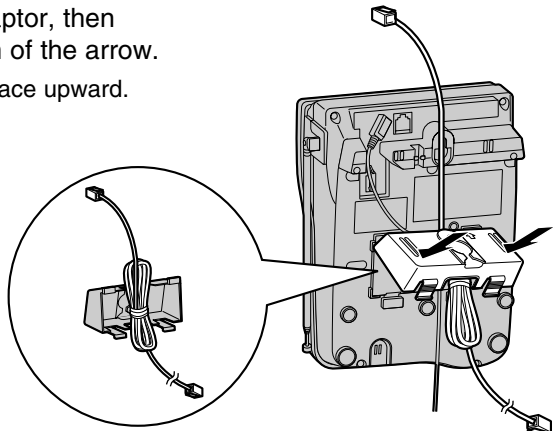

- 4** Install screws using the wall template below. Connect the telephone line cord. Mount the unit, then slide down.
- Extend the antenna.
 - Fasten the telephone line cord to prevent it from being disconnected.

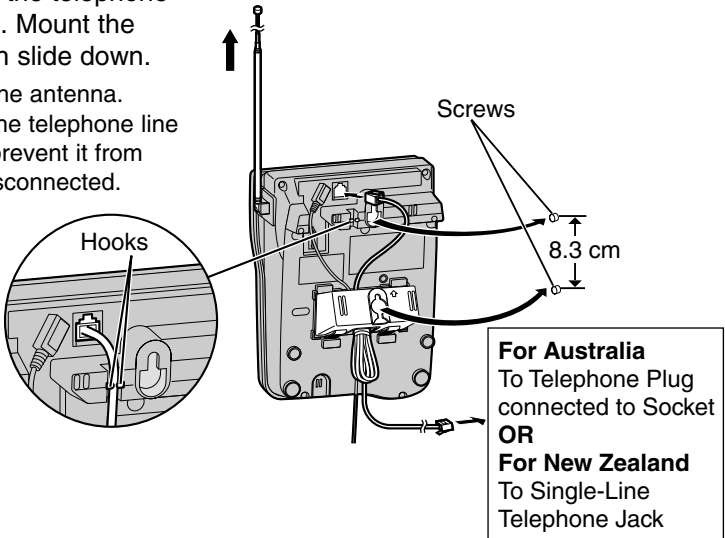

- 5 To charge the handset battery:** Fix the charge contacts (①) and insert the hook to the handset hole (②).
- The IN USE/CHARGE indicator lights.

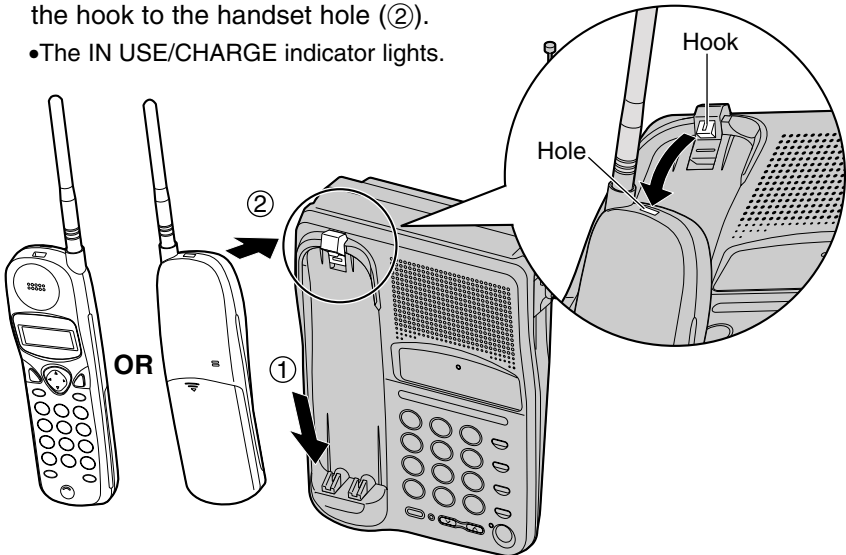

Wall Template

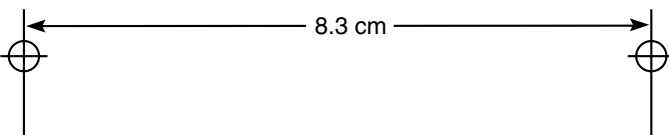

Battery Replacement

If “Recharge” is displayed and/or “[■]” flashes after being fully charged, replace the battery with a new Panasonic P-P102 battery. To avoid memory loss, replace within 3 minutes.

- 1 Press the notch on the battery cover firmly and slide it as indicated by the arrow.

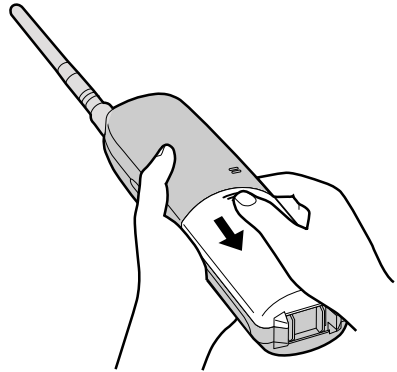

- 2 Remove the old battery. Then install the new one.
 - Insert the battery plug into the connector as shown.

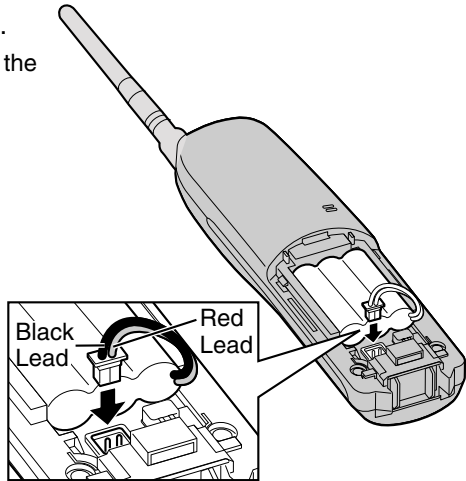

- 3 Close the cover. Make sure you charge the new battery for about 10 hours so that the battery strength indicator appears (p. 12).

Adding Another Phone

This unit will not function during a power failure. To connect a standard telephone on the same line, use a telephone double adaptor (for Australia) or a T-adaptor (for New Zealand).

For Australia

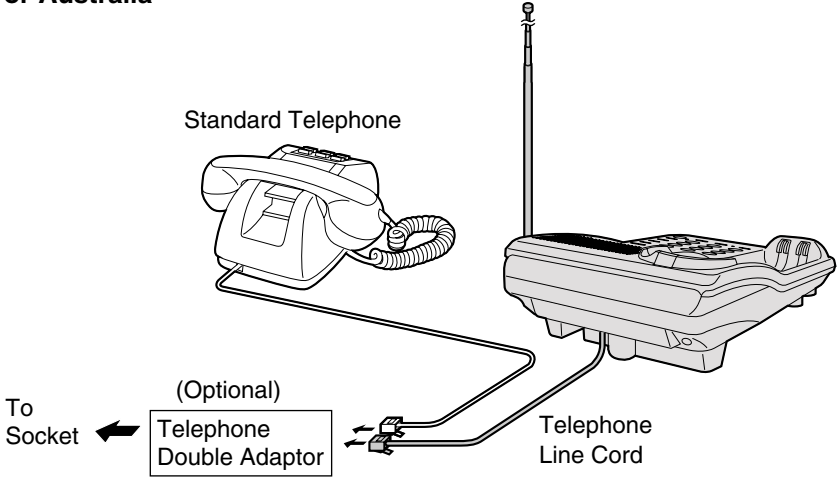

For New Zealand

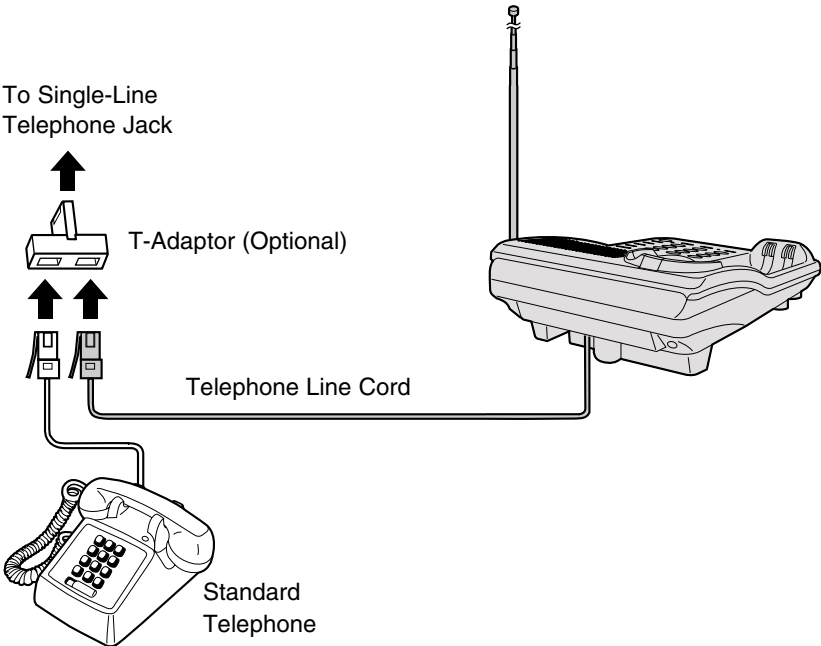

Useful Information

Before Requesting Help

Problem	Remedy
The unit does not work.	<ul style="list-style-type: none">•Check the settings (p. 11–15).•Charge the battery fully (p. 12).•Clean the charge contacts and charge again (p. 13).•Install the battery properly (p. 52).•Place the handset on the base unit and unplug the AC adaptor to reset. Plug in, and try again.•Re-install the battery and place the handset on the base unit (p. 52). Try again.•KX-TC1220ALW and KX-TC1220NZW are not designed to be used with rotary (pulse dialling) services.
“No link to base Place on cradle and try again.” is displayed and an alarm tone sounds.	<ul style="list-style-type: none">•You are too far from the base unit. Move closer and try again.•Place the handset on the base unit and try again.•Plug in the AC adaptor.•Extend the antenna fully.
Static, sound cuts in/out, fades. Interference from other electrical units.	<ul style="list-style-type: none">•Locate the handset and the base unit away from other electrical appliances (p. 3).•Move closer to the base unit.•Extend the antenna fully.•Press EXIT/CH to select a clearer channel.
The handset and/or the base unit do not ring.	<ul style="list-style-type: none">•The ringer volume is set to OFF. Set to HIGH or LOW (p. 18).
The handset display is blank.	<ul style="list-style-type: none">•The handset is in the standby mode (p. 13). Press ▼, ▲, ◀ or ▶ to turn the display on.
The handset display is still blank after pressing ▼ , ▲ , ◀ or ▶ .	<ul style="list-style-type: none">•Charge the battery fully (p. 12).



Problem	Remedy
You cannot program items, such as the day and time adjustment.	<ul style="list-style-type: none">•Programming is not possible while the unit is in conversation or speakerphone mode or when viewing the Caller List/directory list.•Do not pause for over 60 seconds while programming.•Make sure that the unit is in the standby mode.
Previously programmed information is erased.	<ul style="list-style-type: none">•If a power failure occurs, programmed information may be erased. Reprogram if necessary.
You cannot store a name and phone number in the directory.	<ul style="list-style-type: none">•You cannot store an item in the directory while the unit is in the talk or intercom mode.•Do not pause for over 60 seconds while storing.
While programming or searching, the unit starts to ring and stops the program/search.	<ul style="list-style-type: none">•To answer the call, press TALK or DIGITAL SP-PHONE. Start again from the beginning after hanging up.
The unit does not display the caller's phone number.	<ul style="list-style-type: none">•You need to subscribe to a Caller ID service from a telephone company.•Other telephone equipment may be interfering with your phone. Disconnect it and try again.•Other electrical appliances connected to the same outlet may be interfering with the Caller ID information.•Telephone line noise may be affecting the Caller ID information.
The handset display goes to the standby mode while viewing the Caller List.	<ul style="list-style-type: none">•Do not pause for over 60 seconds while searching.

➔ Before Requesting Help

Problem	Remedy
LOCATOR/INTERCOM does not function.	<ul style="list-style-type: none">•The handset is too far from the base unit.•The handset is engaged in an outside call or viewing the Caller List. Wait until the IN USE/CHARGE indicator light goes out.
You cannot redial by pressing REDIAL/PAUSE .	<ul style="list-style-type: none">•If the last number dialled was more than 32 digits long, the number will not be redialled correctly.•The button has a double function as either redial or pause. It will redial the last number dialled if pressed at the outset of a call (p. 21, 22, 24). If another number has been dialled first, it will operate as a pause button (p. 47).
“Recharge” is displayed on the handset, “{ ■ }” flashes or the unit beeps intermittently.	<ul style="list-style-type: none">•Charge the battery fully (p. 12).
You charged the battery fully, but “Recharge” is still displayed and/or “{ ■ }” continues to flash.	<ul style="list-style-type: none">•Clean the charge contacts and charge again (p. 13).•Install a new battery (p. 52).
The IN USE/CHARGE indicator light does not go out after the battery has been charged.	<ul style="list-style-type: none">•This is normal.

For Australian Customers

Panasonic Australia operates a toll free Customer Care Centre. Please phone Panasonic on 132600 for assistance.

For New Zealand Customers

Panasonic New Zealand operates a toll free Customer Support Centre.

Please phone 0800 Panasonic (0800 726276) for assistance.

Safety Instructions



Take special care to follow the safety suggestions listed below.

Safety

- 1) The unit should be connected to a power supply only of the type described in the operating instructions or as marked on the unit.
- 2) When left unused for a long period of time, the base unit should be unplugged from the household AC outlet.
- 3) To minimize the possibility of lightning damage when you know that a thunderstorm is coming, we recommend that you:
 - a) Unplug the telephone line cord from the phone jack.
 - b) Unplug the power supply cord from the AC power outlet.

Installations

Environment

- 1) Do not use this unit near liquids—for example, near a bathtub, washbowl, sink, etc. Damp environments should also be avoided.
- 2) The unit should be kept away from heat sources such as heaters, kitchen stoves, etc. It also should not be placed in rooms where the temperature is less than 5°C or greater than 40°C.
- 3) As the AC adaptor needs to be connected to mains power, ensure that AC mains output is located nearby for easy access.

Placement

- 1) Do not place heavy objects on top of this unit.
- 2) Care should be taken so that objects do not fall onto, and liquids are not spilled into, the unit. Do not subject this unit to excessive smoke, dust, mechanical vibration or shock.
- 3) Place the unit on a flat surface.

For best performance

- 1) If noise prevents the conversation from being understood at the handset, approach the base unit to lessen the noise.
- 2) The handset should be used at the HIGH volume setting when the reception audio is difficult to hear.
- 3) The handset should be fully recharged on the base unit when “Recharge” is displayed and/or “[■]” flashes on the display.
- 4) The handset antenna should not be touched during use because it can effect the handset’s performance.
- 5) The maximum calling distance may be shortened when the unit is used in the following places: Near obstacles such as hills, tunnels, undergrounds, near metal objects such as wire fences, etc.

Safety Instructions

WARNING:

TO PREVENT FIRE OR SHOCK HAZARD, DO NOT EXPOSE THIS PRODUCT TO LIQUID OR ANY TYPE OF MOISTURE.

When a failure occurs which results in the internal parts becoming accessible, disconnect AC adaptor immediately and return this unit to the place of purchase or service centre.

If there is any trouble, disconnect the unit from the telephone line and connect a known working phone. If the known working phone operates properly, do not reconnect the unit to the telephone line until the fault has been repaired. If the known working phone does not operate properly, consult your telephone company.

This equipment has been tested and found to comply with AS/NZS 3548: 1995 limits for electromagnetic interference. Any modifications to any part of the system or to any peripherals may void the EMC compliance of the system or the peripherals.

This equipment will be inoperable when mains power fails.

The earcap on the handset is magnetised and may retain metallic objects.

For New Zealand Users Only

The grant of a Telepermit for any item of terminal equipment indicates only that Telecom has accepted that the item complies with minimum conditions for connection to its network. It indicates no endorsement of the product by Telecom, nor does it provide any sort of warranty. Above all, it provides no assurance that any item will work correctly in all respects with another item of Telepermitted equipment of a different make or model, nor does it imply that any product is compatible with all of Telecom's network services.

This device only responds to Distinctive Alert cadence(s) DA1 & DA3.

WARNING NOTICE:

No "111" or other calls can be made from this device during a mains power failure.

This equipment shall not be set to make automatic calls to the Telecom "111" Emergency Service.

- We recommend that a standard phone which can be used in the case of a power failure be connected to the telephone line at all times.
- This equipment should not be used under any circumstances which may constitute a nuisance to other Telecom customers.

Important Information (For Australia only)

Instructions to customer

Installation

Attached to this apparatus is an approval label. This label is evidence that it is a "Permitted Attachment" which has been authorised to be connected to your telephone service.

Conditions relating to connection and operation of this Permitted Attachment are contained in Telecommunications General By-Law 220 (5).

You are authorised to install this Permitted Attachment yourself by plugging it into the line socket of any regular telephone. You may connect it in place of your existing telephone or to any spare telephone socket installed in your premises.

To disconnect your existing telephone you must first remove its plug from the line socket. You can then insert the plug of your Permitted Attachment into the socket and use your equipment.

If the plug of your existing telephone cannot be readily removed, you will have to remove the screw securing it. To do this proceed as follows:

1. Loosen screw "A" sufficiently to remove the socket cover. (See Fig. 1.)
2. Remove screw "B" and withdraw the plug. (See Fig. 2.)
3. Replace screw "B". (See Fig. 3.) Ensure that it screws completely into the socket recess. (If the screw is too long, increase the hole depth or replace the screw with one 5 mm shorter.)
4. Replace socket cover and tighten screw "A". (See Fig. 4.)

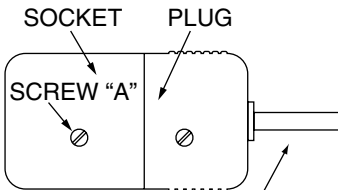

Fig. 1

TELEPHONE CORD
(Connect to the PLUG
as shown in Fig. 1.)

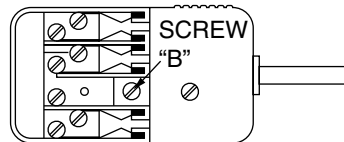

Fig. 2

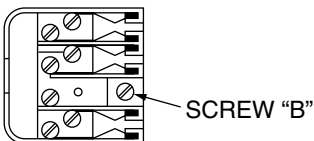

Fig. 3

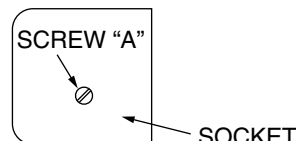

Fig. 4

If you are satisfied with the operation of your telephone service after plugging in your Permitted Attachment, your installation is completed.

You will be unable to connect this Permitted Attachment if your telephone service consists only of a wall phone or an old style telephone which is not connected by means of a modern plug and socket. In such cases a new socket will need to be installed.

Should the Permitted Attachment not operate when plugged into a socket, it is either faulty or unsuitable for operation with your telephone service. It should be returned to the store where purchased or the Authorised Service Centre.

Service difficulties

If at any time a fault occurs on your telephone service carry out the following checks before you call for service:

- Disconnect the Permitted Attachment and try using the service with the normal telephone.
- If the telephone service then operates satisfactorily, the fault is in your Permitted Attachment. Leave the Permitted Attachment disconnected and report the fault to its supplier or agent to arrange for repair.
- If when using the telephone the service is still faulty, report the fault to “Service Difficulties and Faults” for attention.

You are required to keep this Permitted Attachment in good working order while it is connected to your telephone service. Its construction or internal circuit must not be modified in any way without permission.

WARNING

This cordless telephone system does not incorporate provision for secrecy of conversations. Appropriately tuned radio equipment and other cordless telephone systems in close proximity may be used by a third party to monitor and possibly interrupt conversations in progress when this system is on radio operation.

Kyushu Matsushita Electric Co., Ltd.

1-62, 4-chome, Minoshima, Hakata-ku, Fukuoka 812-8531, Japan